

Front View

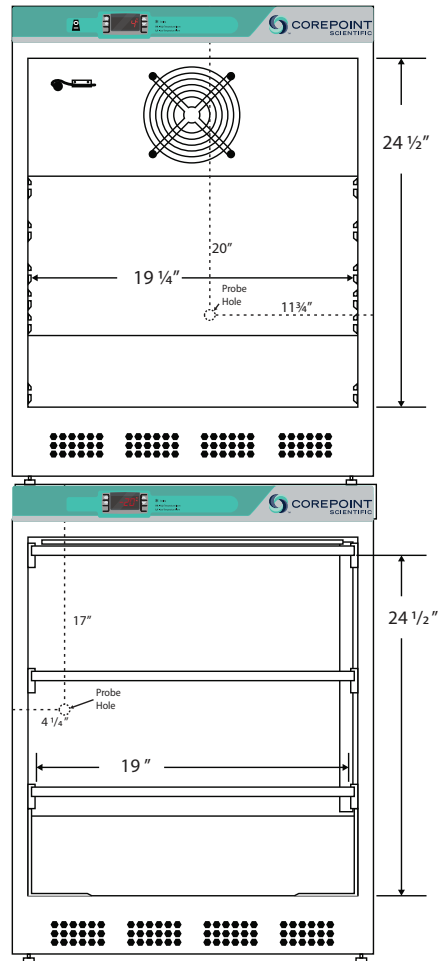

Side View

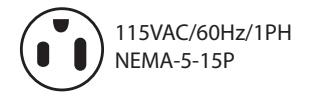
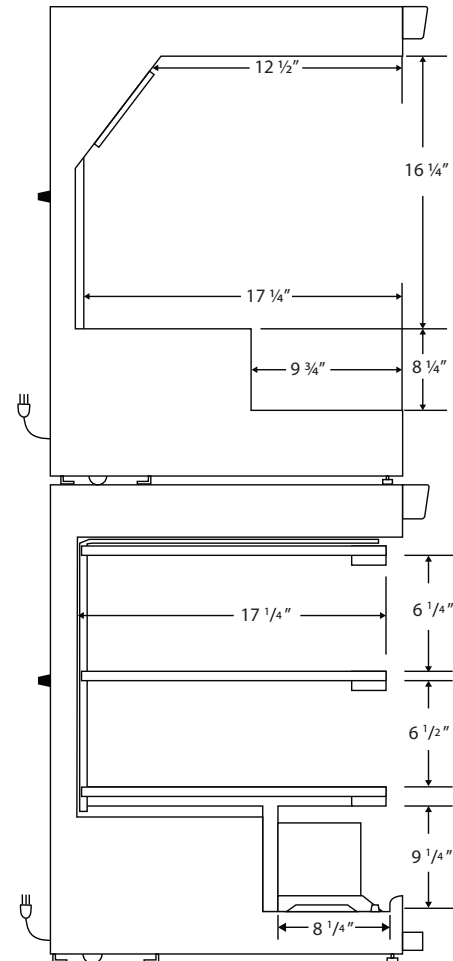

Compartment	Cu. Ft	Defrost	Door	Int Door	Shelves	Interior Dim.			Refrigerant	H.P.	Amps	Weight
						W"	D"	H"				
Refrigerator	4.6	Cycle	1 Solid	0	2 Adj/1 Fixed	19 1/4	17 1/4	24 1/2	R600a	1/8	1.74	200 lbs.
Freezer	4.2	Manual	1 Solid	0	2 Fixed	19	17 1/4	24 1/2		1/8	1.5	

Note: Interior dimensions are estimates and subject to change without notice