

Front View

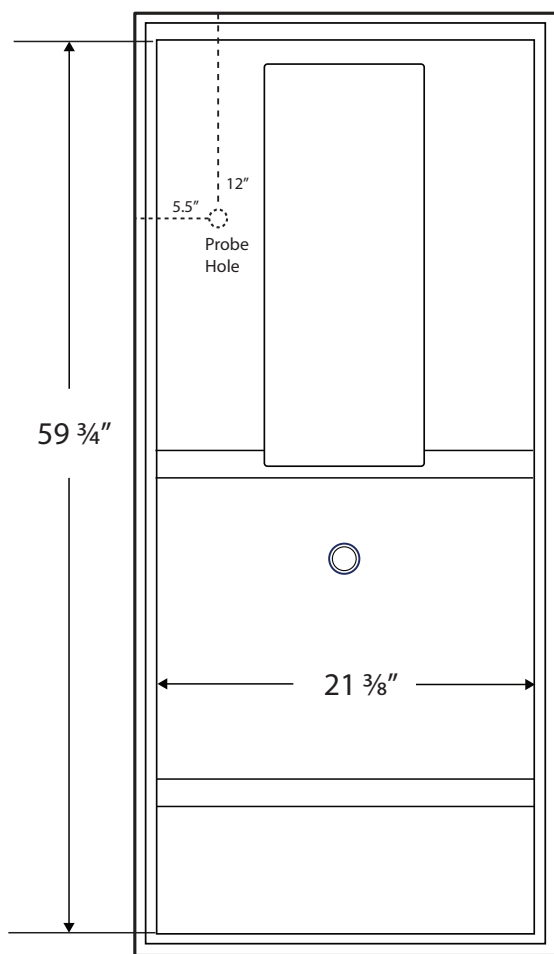
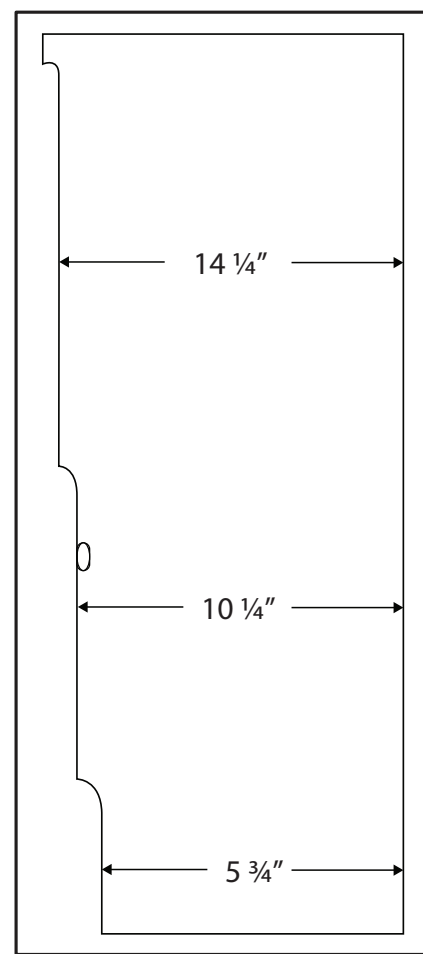

Side View

 115VAC/60Hz/1PH  
 NEMA-5-15P

Cu. Ft	Defrost	Door	Int Door	Shelves	Interior Dim.			Refrigerant	H.P.	Amps	Weight
					W"	D"	H"				
14	Auto	1 Solid	0	3 Adj	21 3/8	14 1/4	59 3/4	R600a	1/4	5	180 lbs.

Note: Interior dimensions are estimates and subject to change without notice